

UNIFLEX-CI/CB

Universal Transmitter for flexible use

**Pt100, Thermocouple, Resistance transducer,
Potentiometer, Voltage, Current**

Temperature linear or linear to specification

Special functions

Local setting via frontkeys or PC

Comprehensive galvanical isolation

Primary switching power supply

PROFILE

The UNIFLEX CI/CB transmitters provide solutions for measurement and monitoring in process control and other industrial applications. Temperature, voltage, current, and resistive signals can be connected without the need for any hardware changes. In addition, the transmitters feature an integrator function, e.g. for analogue/pulse conversion, sample-and-hold tasks, and also differentiation of the input signal are possible.

The transmitters meet the market requirements regarding reliable EMC protection, flexibility and reduced stock keeping. The version with built-in display allows configuration and parameter setting via the front panel keys. With a PC and connecting adapter, both the indicating version (CI) as the "blind" version (CB) can be configured and adjusted remotely. This allows documentation of the adjusted parameters, as also reading of the input signal and parameters during operation.

DESCRIPTION

The transmitter has independent signal inputs for thermocouples, resistive temperature sensors, resistance transducers, DC-voltage and DC-current.

For thermocouple measurement, the cold-junction compensation is provided with a built-in sensor. Resistance thermometers can be connected in 3- or 4- wire configuration. Signals (thermocouples included) can be linearized with up to 8 segments.

The version with extended computing facilities provides additional functions:

- Integration
- sample-and hold and
- differentiation.

The functions are triggered via a control input which replaces the resistive input.

INPUT CIRCUIT MONITOR

Resistance thermometer, thermocouples, resistance transducers are always monitored for break.

Signalling options

- red LED in front (lights up on alarm)
- via switching output (selection of energized or de-energized or not operational)
- via the output signal (selectable for upscale or downscale).

SENSOR SIGNAL CORRECTION

Sensor signal correction is used to match sensor and transmitter for tolerance-compensated readings.

Fig. 1 Sensor signal correction

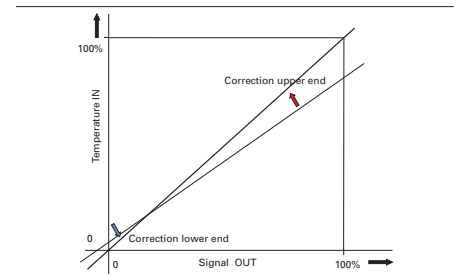

Two different corrective methods are available

- Correction with lower and upper input signal within the selected span or
- Setting of values from the calibration table (scaling).

Subsequent corrections during operation are possible with both versions, by means of the front panel key(s). The curve can be adjusted for offset and for gain.

LIMIT SIGNALLING

- Min. and max. alarm (adjusted in engineering units, together with computing function in %). Adjustable between -10 and 110 % referred to the output signal span.

Hysteresis

- programmable in engineering units or in % in the range from 0,0... 99,9 referred to the output signal span.

Signal suppression (response delay)

- programmable from 0... 999 s. All alarms shorter than the selected delay are ignored.

Signalling

- red LED in front panel (lights up on alarm)
- switching output (selection of energized or de-energized or no operation)

FILTER

Via built-in mathematical filter. It is adjustable for time constant and bandwidth.

Fig. 2 Filter function

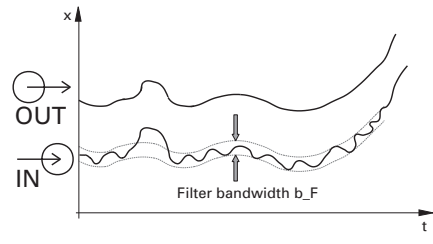

The bandwidth is the tolerance above and below the process value, in which the filter is active. Changes of the process value larger than the adjusted bandwidth are not filtered and will be transferred directly to the output.

INTEGRATOR

Thermocouple as DC signals can be integrated with variable time constants.

DIFFERENTIATOR

Supplies the differential quotient of the input signal during a timed period. Application include the provision of a tendency or trend signal for feed-forward control, signaling of sudden changes in the process, etc.

SAMPLE-AND-HOLD AMPLIFIER

The sample-and-hold amplifier stores input signals which are only present for a short time. Typical applications are: storage of discontinuous set-values, and storage of signals in the case of a fault in the signal source.

Fig.3 Dimensions (in mm)

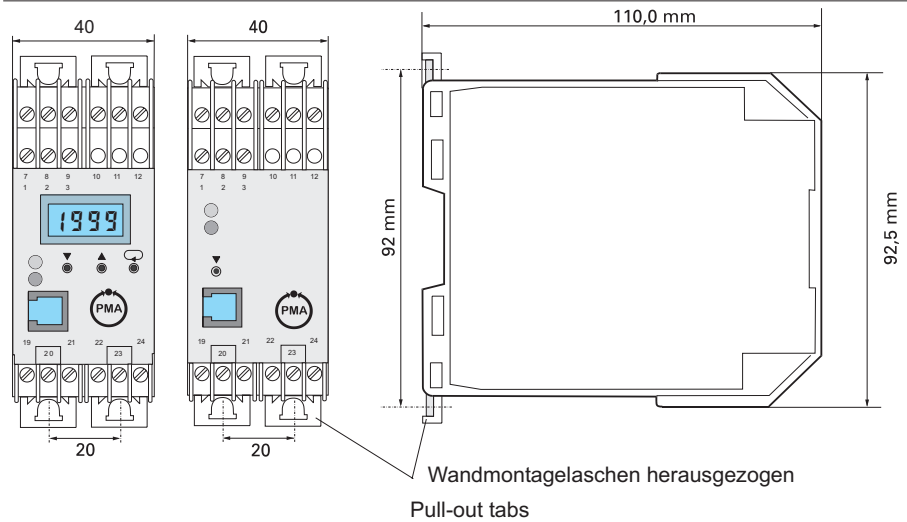

TECHNICAL DATA

INPUT (configurable)

Resolution: approx. 20 000 steps referred to full span.

Measuring cycle: 200 ms

THERMOCOUPLES

Measurement limits (TC group 1)

Type	Start [°C]	End [°C]
E	-100	1000
J	-100	1200
L	-100	900
K	-100	1370
N	-100	1300
T	-100	400
W(C)	0	2315

Smallest span 4(2) mV¹⁾

Measurement limits (TC group 2)

Type	Start [°C]	End [°C]
R	0	1760
S	0	1760
B ^{*)}	(0)400	1820

Smallest span 2 mV

Input resistance: 1MΩ

Linearization

built-in (temperature linear) with optimized positioning of supporting points for reduced error.

Conformity error

for TC-group 1: ≤ 0,2 K
for TC-Group 2: ≤ 0,5 K^{*)}

Input circuit monitor

for break and reversed polarity

Cold-junction-compensation

internal or external (0...60 °C) selectable

Display error: ≤ 3 K ± 1 d

RESISTANCE THERMOMETER PT100 DIN IEC

Start [°C]	End [°C]	Min ¹⁾	Sensor current
-200	+650	50 (25) K	< 0,4 mA

Connection

Three- and four-wire configuration

Lead resistance: ≤ 30 Ω per wire

Input resistance: 1 MΩ

Linearization

built-in with optimized positioning of supporting points for smallest error

Conformity error: ≤ 0,1 K

Input circuit monitor: for break

Display error: ≤ 1 K ± 1 d

RESISTANCE & POTENTIOMETRIC TRANSDUCER

Range	Start	End	Min ¹⁾	Measuring current
1	0	400	20 (10)	ca. 0,4 mA
2	0	1500	50	ca. 0,1 mA

Values given in Ω

Connection

Transducer: 3-wire connection, current through resistor

Resistance: 3 or 4-wire connection

Lead resistance: ≤ 30Ω per lead

Input resistance: 1MΩ

Input circuit monitor: for break

*) Linearisation for type B from +400 °C onwards

¹⁾ Figure in brackets with approx. twice the effect

DIRECT VOLTAGE mV signals

Range	Start	End	Min.
1	-3	23	2,5
2	-11	69	9
3	0	160	15

Input resistance: 1 M Ω

V signals-via internal voltage

Range	Start	End	Min.
1	-0,6	4,4	400 mV
2	-2	13	1000 mV
3	0	30	2000 mV

divider

Input resistance: approx. 100 k Ω

Range	Start	End	Min.
1	-1	7,3	1
2	-3	22	2
3	0	50	4

DIRECT CURRENT mA

Input resistance: approx. 18 Ω

ADDITIONAL LINEARIZATION

Possible for all input signals -except potentiometric transducers- with 8 segments respect. 9 supporting points.

CONTROL INPUT

designed for external potential-free contact and small currents.
Min. duration of control signal: ≥ 100 ms

PERMISSIBLE INTERFERENCE at input

(to DIN IEC 770 6.2.4)

Common mode suppression: negligible
Series mode: no effect up to
450 mV_{rms} for TC (type S)
1 V_{rms} for mV (0...50 mV)
750 mV_{rms} for Pt100 (0...100 °C)
10V_{rms} for DC 0...4V / 0...5 mA

OUTPUT

The required adjusted output signal is activated via software. The current and voltage output signals are always available in parallel.

Synchronism error: $\leq 0,5$ %

Fig. 4 Electrical connections

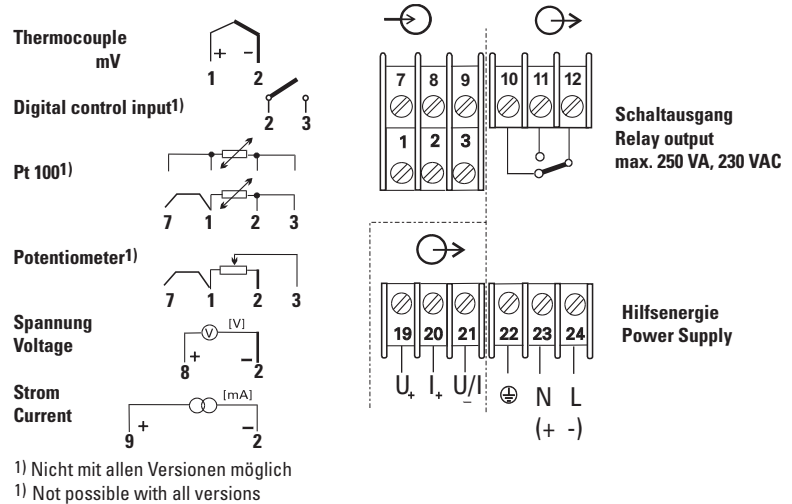

STANDARD CURRENT SIGNAL

0...20 mA or 4...20 mA
Output sense: direct or inverse

Controlled range: -0,3...23 mA

Load: 0...700 Ω

Load effect: $\leq 0,1$ % / 100 Ω

STANDARD VOLTAGE SIGNAL

0...10 V parallel to current signal
Output sense: direct or inverse

Controlled range: - 0,15...11,5 V

Load: ≥ 2 k Ω (not continuous short-circuit proof)

Load effect: negligible with ≥ 2 k Ω

Resolution: 13 bit (9000 steps)

CHARACTERISTIC

linear

Conformity error

Incl. factory calibration error $\leq 0,06$ % of fsd

Factory calibration

at 23 °C; RT ± 1 K, TC ± 2 K

Hysteresis: $\leq 0,02$ % fsd

Reproducibility: $\leq 0,01$ %

Input circuit monitor

Output action selectable upscale or downscale.

DYNAMIC RESPONSE

For a step change from 10 to 90 % of input signal

Output follows input: approx. 630 ms

Settling time after external "Hold" signal: 100 ms + max. 600 ms

SWITCHING OUTPUT

One relay with potential-free change-over contact.

Contact rating: max. 250 VAC, 1 A min. 10 V, 0,1 A; Energized or de-energized operation configurable.

Operating mode: selectable for input circuit monitor and/or limit signalling.

DISPLAY

- **Version with indicator** (UNIFLEX CI) 4-digit LCD, 7 mm high, range of display -200...-99,9...0...9999.
- Green LED: ready for operation
- Red LED: input circuit monitor or limit signaller activated.
- **Version without indicator** (UNIFLEX CB)
- Green LED: ready for operation
- Red LED: input circuit monitor or limit signaller activated.
- Blinking mode LED's for sensor signal correction mode.

¹⁾ Figure in brackets with approx. twice the effect

OPERATION

Version with indicator

Configuration, Parameter setting and input signal correction are menu-guided via three front-panel keys.

Version without indicator

Input signal correction is done by means of a single front key and a digital voltmeter for the output signal.

PC-based operation

For both versions, additional software is available (Engineering tool based on Windows) for configuration, parameter setting, and input signal correction.

SERIAL INTERFACE

RS 232C with active adapter

COMPUTING FUNCTIONS

FUNCTIONS without CONTROL INPUT

- Input signal correction
- 1st-order filter with adjustable operating range (bandwidth)
- Linearization with 8 segments
- \sqrt{x} , where $\sqrt{-x} = 0$
- x^2

FUNCTIONS with CONTROL INPUT

- Input signal correction
- 1st-order filter with adjustable operating range (bandwidth)
- Linearization with 8 segments
- \sqrt{x} , where $\sqrt{-x} = 0$
- X2
- **Integrator** with adjustable time constant ($t=0,1...999,9$ min.) and adjustable input offset (P1).

Formula: $y(t)=Y(t-T_r)+T_r/t*((x+P1)$
The control input resets integrator to zero.

- **Differentiator** with adjustable time constant ($t=0,1...999,9$ min.) and adjustable gain (P1).

Formula:
 $y(t)=T/(t+T_r)*(y(t-T_r)+P1*[x(t)-x(t-T_r)])$
The control input resets differentiator to zero.

- **Sample-and-hold**
Activated control input holds output signal according to process value.

Fig.5 Software setting CON 1

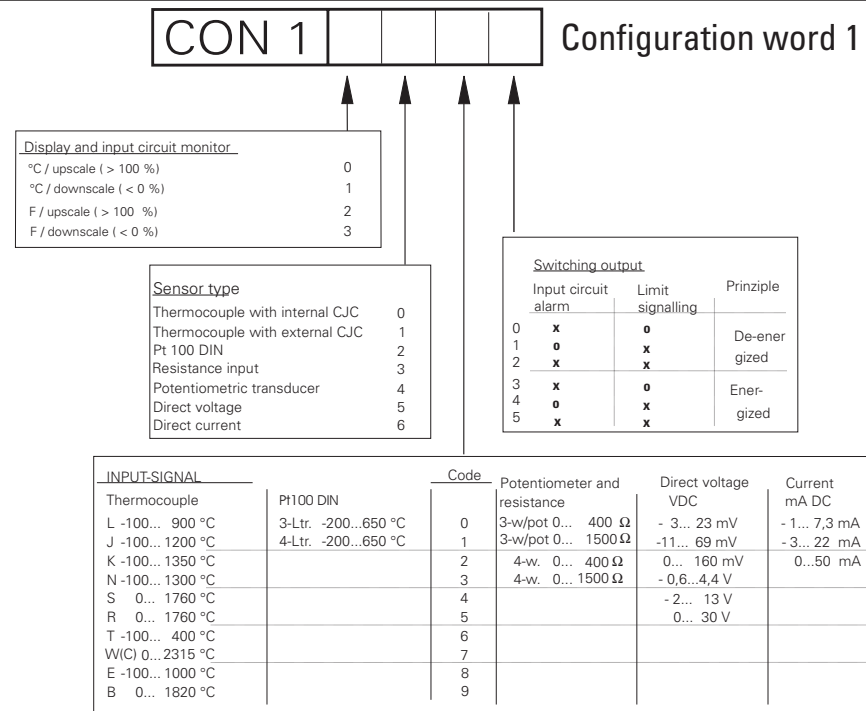
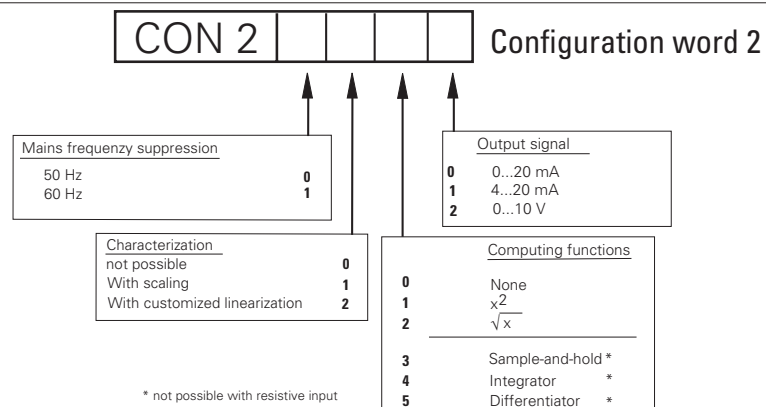

Fig. 6 Software setting CON 2



POWER SUPPLY

AC(DC) SUPPLY

85...264 VAC¹⁾, 50 or 60 Hz

Power consumption: approx. 5,3 VA

UNIVERSAL SUPPLY

18...50 VDC / 18... 40 VAC

Consumption: approx. 1,9 W/2,9 VA

POWER SUPPLY EFFECT

negligible within specified limits.

Behavior with mains failure

no loss of configuration data.

GALVANICAL ISOLATION

Between input and output and power supply.

TEST VOLTAGES

Between input and output: 500 VAC
Between mains and in/output: 3,75 kVAC

¹⁾ also suitable for DC
²⁾ In field housing max. + 54 °C

ENVIRONMENTAL CONDITIONS

TEMPERATURE LIMITS

For specified accuracy: 0...55 °C

For operation: -10 ... + 60 °C²⁾

Storage: -20 ... + 70 °C

TEMPERATURE EFFECT

(within -10...+ 60 °C)

On span start

R - input: ≤ 0,03 % / 10K

TC/U/I - input: ≤ 0,04 % / 10K

On span

R - input: ≤ 0,05 % / 10K

TC/U/I - input: ≤ 0,05 % / 10K

EFFECT of internal cold junction compensation

≤ 0,13 K / 10 K

RELATIVE HUMIDITY

90 % rH, no condensation

SHOCK AND VIBRATIONS

DIN IEC 68-2-6/Fc and DIN 68.2.29/Eb

ELECTROMAGNETIC COMPATIBILITY

Complies with EN 50081-1 and EN 50082-2 for unlimited use within rural and industrial areas.

EXPLOSION PROTECTION

No explosion protection.

SAFETY CHARACTERISTICS

According to EN 61010-1

Excess-voltage category III

Pollution degree 2

Operating voltage range 300 V

Protective class I

CE-marking

According to European directives for "Electromagnetic compatibility" and "Electrical equipment use within specified voltage limits (safety characteristics).

ORDERING INFORMATION

If not specified otherwise, the transmitter will be delivered with the following standard settings.

UNIFLEX CI/CB Standard version
CON1 0200; CON2 0001.

Range 0...150 °C, Pt100, 3-wire configuration. Input circuit monitoring upscale action. Switching output de-energized, set to span start and end. Hysteresis 5%, suppression 2s, filter time 0,1 s, bandwidth 5 °C.

Version with extended computing function

CON1 0540; CON2 0000

Range 0...10 V, limit alarm not active, set to span start and end. Hysteresis 5%, suppression 2 s, filter time 0,1 s, bandwidth 0,5 V.

Time constant 0,1 min.

Input offset/gain P1 1,0

GENERAL

HOUSING

Polycarbonate, glasfibre reinforced, self-extinguishing

DIMENSIONS

93 x 111 x 40 mm

MODE OF PROTECTION

Housing and terminals IP30

ELECTRICAL CONNECTION

screw terminals for max. 2,5 mm²

WEIGHT

0,225 kg net

MOUNTING

Wall or 35 mm rail to DIN 46277

MOUNTING POSITION

Vertical, dense mounting and temperatures ≥ 50 °C forced ventilation is recommended.

ACCESSORIES

Operating notes: D / E / F
9499-040-43801

OPTIONAL ACCESSORIES

Description	Order-no.:
Active adapter for connection of UNIFLEX CI/CB to a RS232 interface of a laptop or PC	9407-998-00001
Engineering tool for setting of configuration and parameters, read-out and documentation, base Windows (3.11). Licence (1)	9407-999-000801
Field housing for UNIFLEX transmitter. Protection IP 67, with transparent lid. Cable gland PG 13,5.	9407-290-01001

Fig. 7 Field housing IP 67

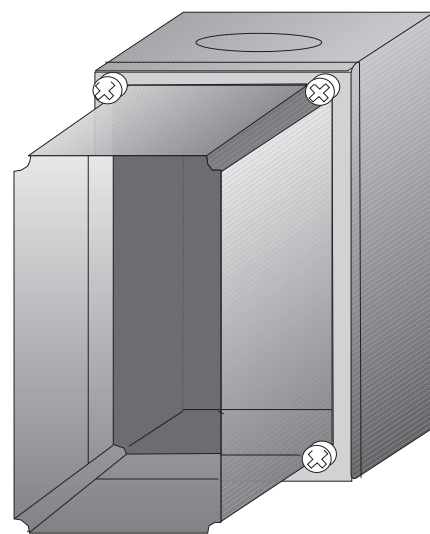



Display and function	
without display (CB)	
Standard transmitter	0
Transmitter with intergrator, differen- tiator, sample-and-hold ¹⁾	,2
With display (CI)	
Standard transmitter	1
Transmitter with intergrator, differen- tiator, sample-and-hold ¹⁾	2

¹⁾ Not possible with resistive input

Configuration and supply voltage	
Standard-configuration	
AC supply 85...265 VAC (UC)	1
Universal supply 18...40 VAC / 18...50 VDC	2
Customer specific configuration	
AC supply 85...265 VAC (UC)	3
Universal supply 18...40 VAC / 18...50 VDC	4



Deutschland

PMA Prozeß- und Maschinen- Automation GmbH
Miramstrasse 87, D-34123 Kassel

Tel./Fax: (0561) 505 - 1307/-1710
E-mail: mailbox@pma-online.de
Internet: <http://www.pma-online.de>

Your local distributor: